

Codice Prodotto <i>Product Code</i>	9.150.001.30	 Fornito Privo di Lubrificante! Supplied without oil!
Descrizione <i>Description</i>	L-150B	

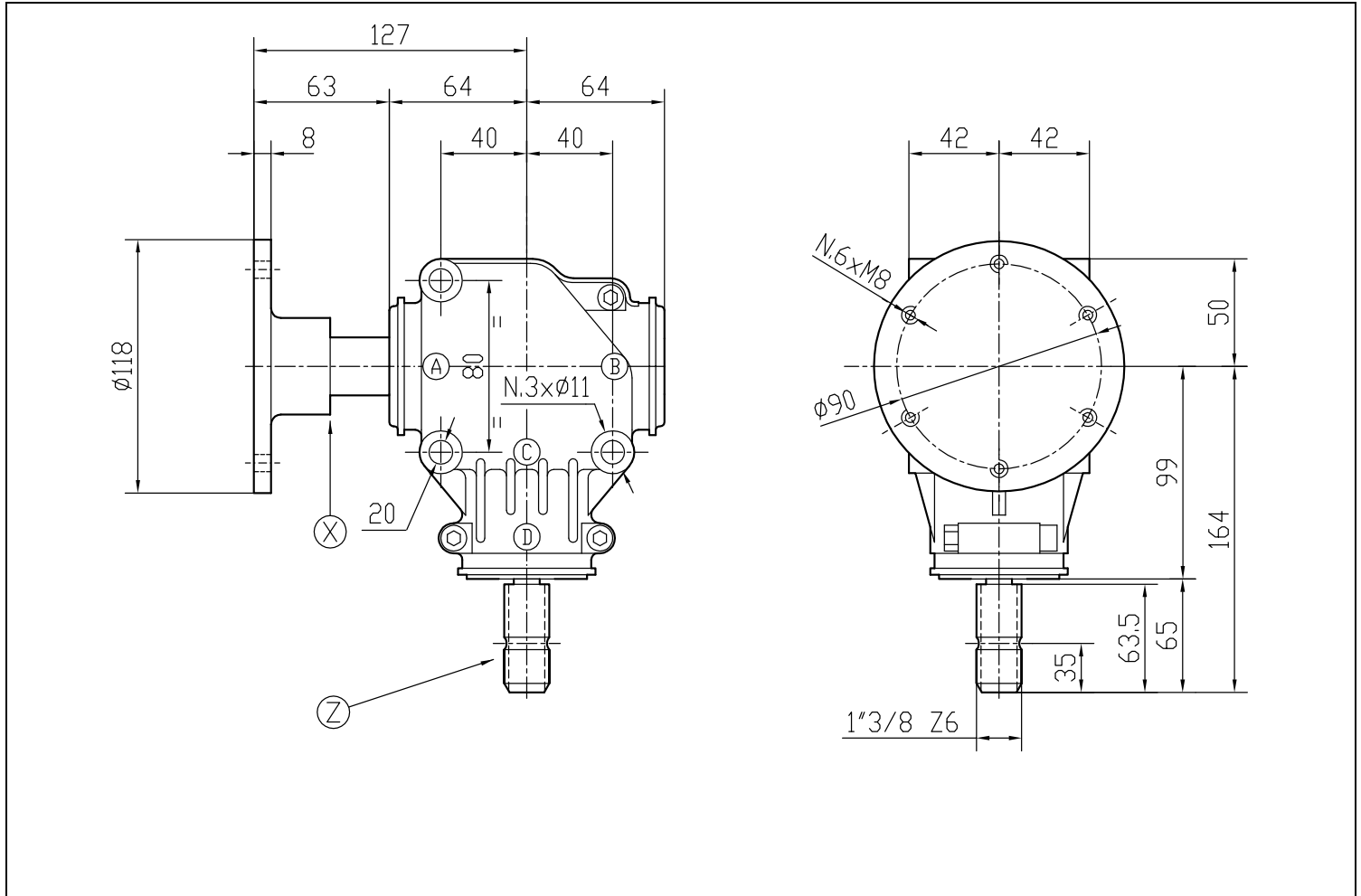
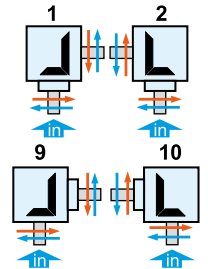

Tipo * Type *	Rapporto Ratio	Giri entrata Input r.p.m.	Potenza entrata Input Power [kW]	Momento Torcente Uscita Output Torque [daNm]	Peso Weight [kg]	Albero Ingresso Input shaft	Sensi di Rotazione Direction of Rotation
0	1:1	540	8,1	13,9	3,5	X-Z	

* Tipo: M= Moltiplicatore di Giri R= Riduttori di Giri 0= Rinvio 1:1 RC= Riduttore Cambio di Velocità RM= Moltiplicatore Cambio di Velocità
 * Type: M= Speed Increaser R= Reducer 0= Gearbox 1:1 RC= Speed-Change Reducer RM= Speed-Change Increaser